

ALESSANDRO

- Poltrona
-Fauteuil
-Chair
- Poltrona 1br
-Bat 1p
-Chair 1arm
- Poltrona centrale
-Chauffeuse
-Chair no arms
- Poltrona Terminale
-Fauteuil Terminal
-Terminal Chair

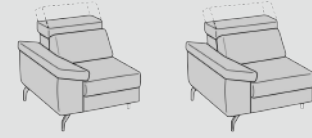

120



90

110

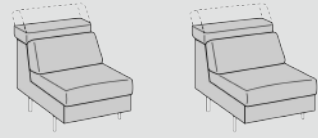

60

80



114x118

- 2 Posti
-2 Places
-2 Seaters



180

- 2 Posti 1br
-Bat 2p
-2st 1arm



150

- 3 Posti
-3 Places
-3 Seaters

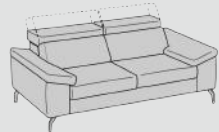

220

- 3 Posti 1br
-Bat 3p
-3st 1arm

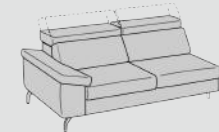

190

- Angolo
-Angle
-Corner

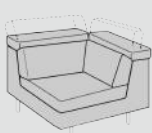

114 x 114

- Angolo terminale
-Angle terminal
-Terminal corner

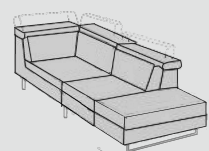

114 x 232

- Chaise Longue



90 x 165



110 x 165

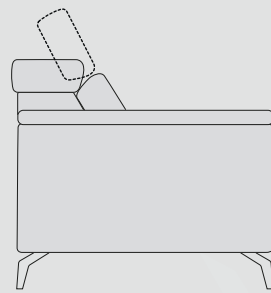
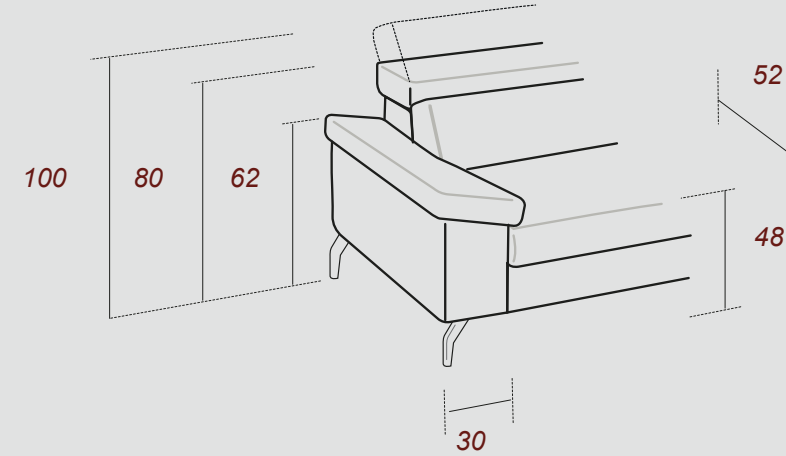

102

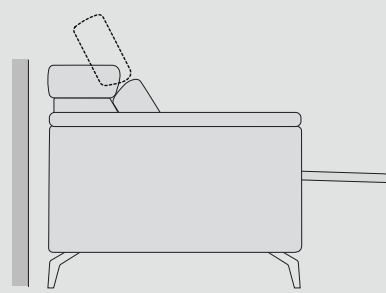

166

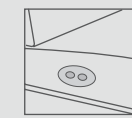

Pulsantiera Touch

Touch control panel

Panneau de commande tactile

OPTIONAL

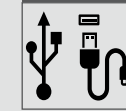

Connettore USB

NON DI SERIE

USB connector

NOT SERIES

Connecteur USB

HORS SÉRIE

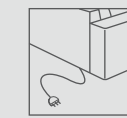

Attacco elettrico, di serie

Electric connection, standard.

Connexion électrique, standard.

OPTIONAL

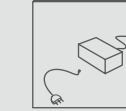

Alimentatore e batteria ricaricabile.

NON DI SERIE

Power supply and battery rechargeable.

NOT SERIES

Alimentation et batterie rechargeable.

HORS SÉRIE

Fusto Abete / multistrato / truciolare
Assemblaggio Assemblaggio con colla e chiodi
Cinghie Cinghie elastiche ad alta resistenza, intrecciate e incollate
Schienale Poliuretano espanso 21 kg/m3
Braccioli Poliuretano espanso 21 kg/m3
Seduta Poliuretano espanso 35 kg/m3

Carcasse Sapin / Bois aggloméré EL / Fibres en bois/ Multicouche peuplier
Assemblage Emboîtement avec colle, clous et pointes
Sangles Elastiques à haute résistance, tressées et clouées
Dossiers Mousse polyuréthane 21 kg/m3
Accoudoirs Mousse polyuréthane 21 kg/m3
Assises Mousse polyuréthane 35 kg/m3

Frame Wood and derived
Assembly Assembly with screws and glue
Belts Elastic and crossing belts
Back Seat Mousse Polyurethane 21 kg/m3
Arms Mousse Polyurethane 21 kg/m3
Cushion Seat Mousse Polyurethane 35 kg/m3

Finitura Piedi in Metallo
Finition des Piedes Métal
Feet Metal Finishing

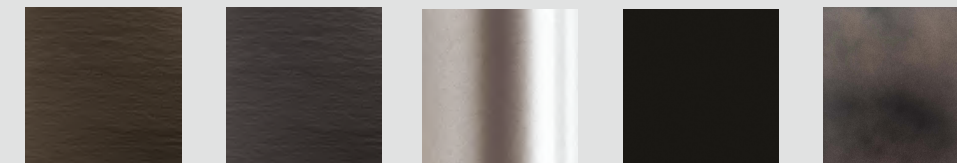

MOKA

GRAFITE

CHROME

BLACK

FUME'

