

BETA

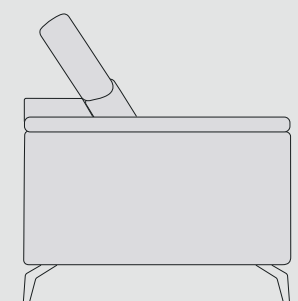

100

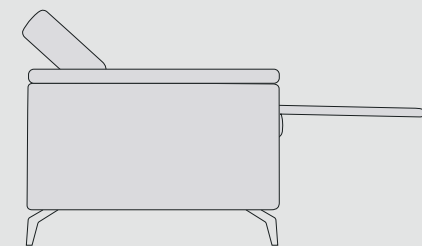

160

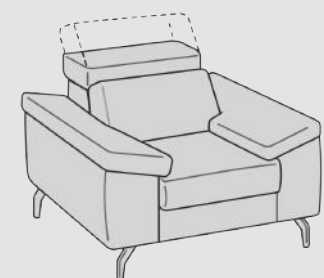
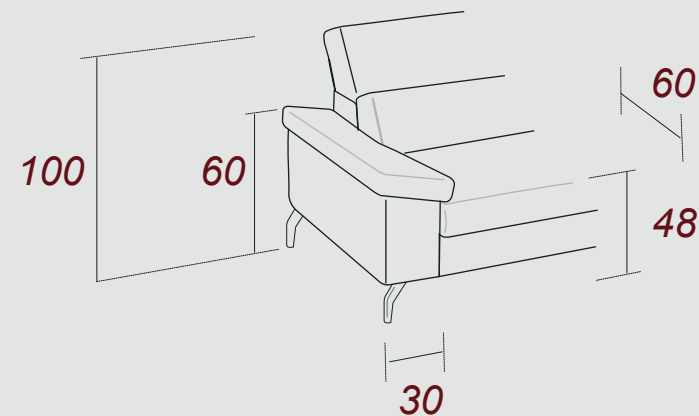

120

Poltrona
Fauteuil
Chair

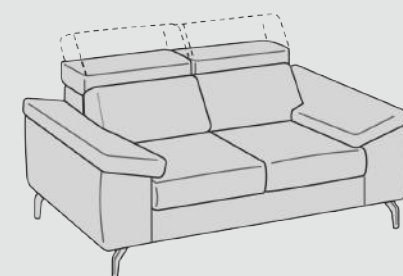

180

2p
Bat 2pl
2 Str

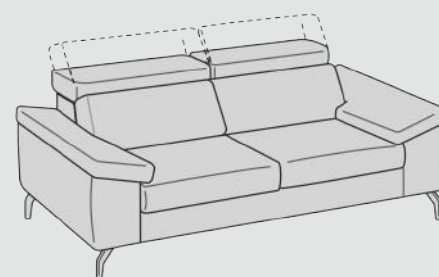

224

3p
Bat 3pl
3 Str

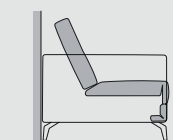

Posizione chiusa
Closed position
Position fermée

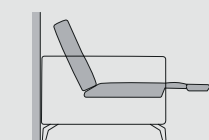

Posizione TV
TV position
Position TV

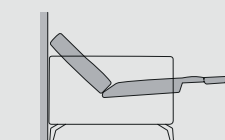

Posizione Full Relax
Full Relax Position
Position de relax complète

Metodo di controllo
Control method
Methode de controle

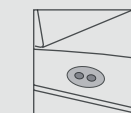

Pulsantiera Touch

Touch control panel

Panneau de
commande tactile

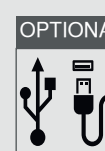

Connettore USB

NON DI SERIE

USB connector

NOT SERIES

Connecteur USB

HORS SÉRIE

Kit di attivazione
Activation kit
Kit d'activation

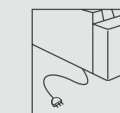

Attacco elettrico,
di serie

Electric connection,
standard.

Connexion électrique,
standard.

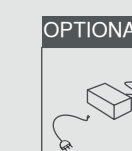

Alimentatore e batteria
ricaricabile.

Power supply and battery
rechargeable.

Alimentation et batterie
rechargeable.

Fusto Abete / multistrato / truciolare
Assemblaggio Assemblaggio con colla e chiodi
Cinghie Cinghie elastiche ad alta resistenza, intrecciate e incollate
Schienale Poliuretano espanso 21 kg/m3
Braccioli Poliuretano espanso 21 kg/m3
Seduta Poliuretano espanso 35 kg/m3

Carcasse Sapin / Bois aggloméré EL / Fibres en bois/ Multicouche peuplier
Assemblage Emboîtement avec colle, clous et pointes
Sangles Élastiques à haute résistance, tressées et clouées
Dossiers Mousse polyuréthane 21 kg/m3
Accoudoirs Mousse polyuréthane 21 kg/m3
Assises Mousse polyuréthane 35 kg/m3

Frame Wood and derived
Assembly Assembly with screws and glue
Belts Elastic and crossing belts
Back Seat Mousse Polyurethane 21 kg/m3
Arms Mousse Polyurethane 21 kg/m3
Cushion Seat Mousse Polyurethane 35 kg/m3

No Finitura Piedi
No Piedes Finition
No Feet Finishing

SISTEMI E COMPLEMENTI DISPONIBILI
AVAILABLE SYSTEMS AND COMPLEMENTS
SYSTÈMES ET COMPLÉMENTS DISPONIBLES



* **Disegno a scopo dimostrativo**
* **Dessin à des fins de démonstration**
* **Drawing for demonstration purposes**