

# ITACA

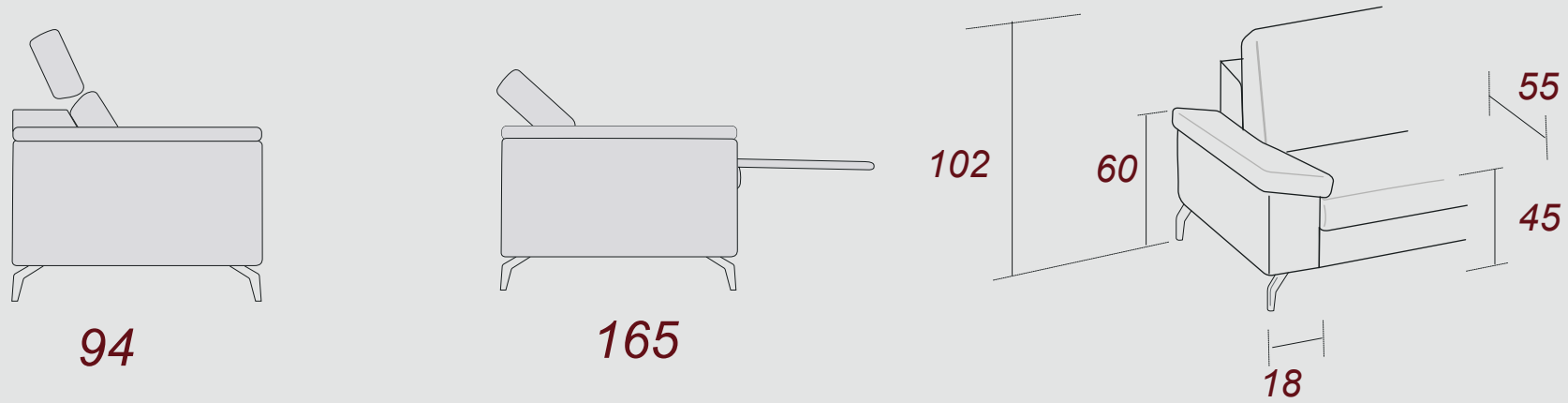

Les versions 2 places et 3 places de ce modèle sont disponibles uniquement en version fixe ou avec deux relaxations électriques.

The 2 seater and 3 seater versions of this model are available only in a fixed version or with two electric recliners.

Le versioni 2 posti e 3 posti di questo modello sono disponibili solo nella versione fissa o con due relax elettrici.



-Poltrona  
-Fauteuil  
-Chair

-2 Posti  
-2 Places  
-2 Seaters

-3 Posti  
-3 Places  
-3 Seaters

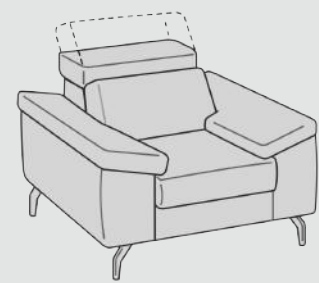

104

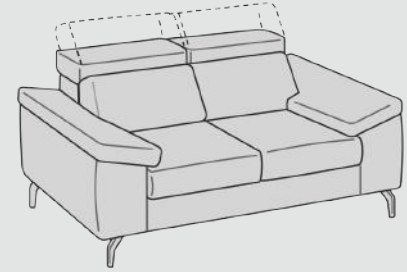

172

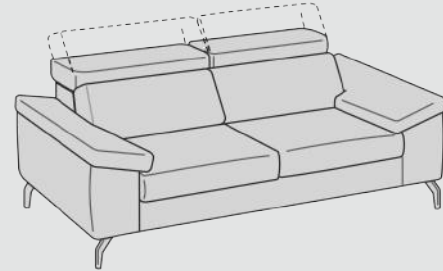

206

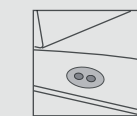

Pulsantiera Touch

Touch control panel

Panneau de commande tactile

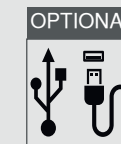

Connettore USB

USB connector

Connecteur USB

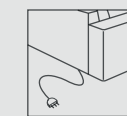

Attacco elettrico, di serie

Electric connection, standard.

Connexion électrique, standard.

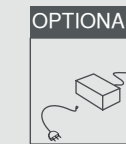

Alimentatore e batteria ricaricabile.

Power supply and battery rechargeable.

Alimentation et batterie rechargeable.

**Fusto** Abete / multistrato / truciolare  
**Assemblaggio** Assemblaggio con colla e chiodi  
**Cinghie** Cinghie elastiche ad alta resistenza, intrecciate e incollate  
**Schienale** Poliuretano espanso 21 kg/m<sup>3</sup>  
**Braccioli** Poliuretano espanso 21 kg/m<sup>3</sup>  
**Seduta** Poliuretano espanso 35 kg/m<sup>3</sup> e molle greche

**Carcasse** Sapin / Bois aggloméré EL / Fibres en bois/ Multicouche peuplier  
**Assemblage** Emboîtement avec colle, clous et pointes  
**Sangles** Élastiques à haute résistance, tressées et clouées  
**Dossiers** Mousse polyuréthane 21 kg/m<sup>3</sup>  
**Accoudoirs** Mousse polyuréthane 21 kg/m<sup>3</sup>  
**Assises** Mousse polyuréthane 35 kg/m<sup>3</sup> et ressorts

**Frame** Wood and derived  
**Assembly** Assembly with screws and glue  
**Belts** Elastic and crossing belts  
**Back Seat** Mousse Polyurethane 21 kg/m<sup>3</sup>  
**Arms** Mousse Polyurethane 21 kg/m<sup>3</sup>  
**Cushion Seat** Mousse Polyurethane 35 kg/m<sup>3</sup> and spring

