

LOUVRE

-Poltrona
-Fauteuil
-Chair

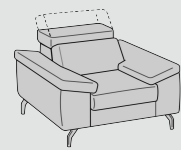

108

-Poltrona 1br
-Bat 1p
-Chair 1arm

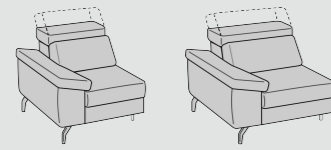

85

102

-Poltrona centrale
-Chaise
-Chair no arms

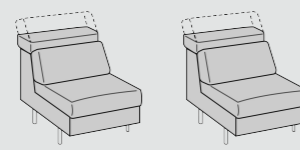

61

77

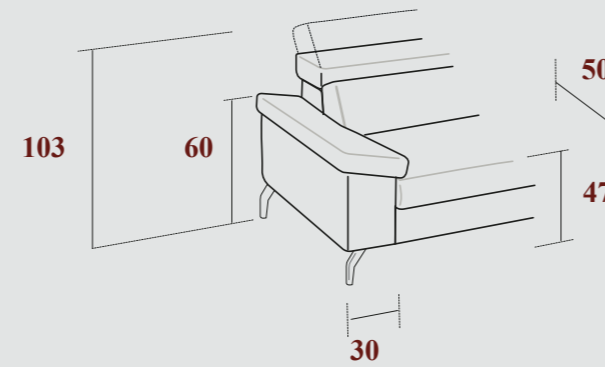

-2 Posti
-2 Places
-2 Seaters

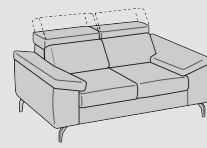

170

-2 Posti 1br
-Bat 2p
-2st 1arm

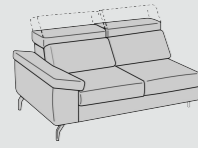

146

-Angolo quadro
-Angle carre
-Square corner

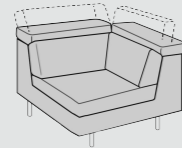

108 X 108

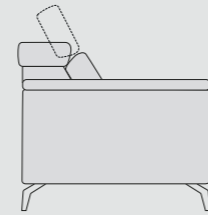

100

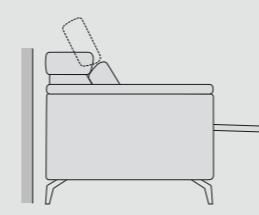

156

-3 Posti
-3 Places
-3 Seaters

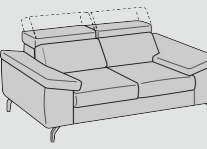

204

-3 Posti 1br
-Bat 3p
-3st 1arm

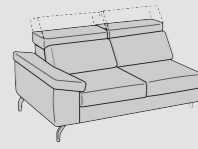

180

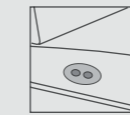

Pulsantiera Touch

Touch control panel

Panneau de commande tactile

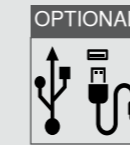

Connettore USB

USB connector

Connecteur USB

HORS SÉRIE

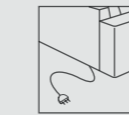

Attacco elettrico, di serie

Electric connection, standard.

Connexion électrique, standard.

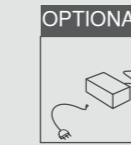

Alimentatore e batteria ricaricabile.

Power supply and battery rechargeable.

Alimentation et batterie rechargeable.

HORS SÉRIE



Fusto
Assemblaggio
Cinghie
Schienale
Braccioli
Seduta
Testiera

Abete / multistrato / truciolare
Assemblaggio con colla e chiodi
Cinghie elastiche ad alta resistenza, intrecciate e incollate
Ovatta
Poliuretano espanso 21 kg/m3
Poliuretano espanso 35 kg/m3
Ovatta



Carcasse
Assemblage
Sangles
Dossiers
Accoudoirs
Assises
Tetieres

Sapin / Bois aggloméré EL / Fibres en bois/ Multicouche peuplier
Emboîtement avec colle, clous et pointes
Elastiques à haute résistance, tressées et clouées
Ouate
Mousse polyuréthane 21 kg/m3
Mousse polyuréthane 35 kg/m3
Ouate



Frame
Assembly
Belts
Back Seat
Arms
Cushion Seat
Headrests

Wood and derived
Assembly with screws and glue
Elastic and crossing belts
Wadding
Mousse Polyurethane 21 kg/m3
Mousse Polyurethane 35 kg/m3
Wadding

