

MARCHESI

-Poltrona
-Fauteuil
-Chair



112

-Poltrona 1br
-Bat 1p
-Chair 1arm

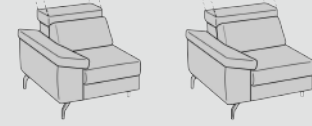

86

100

-Poltrona centrale
-Chaiseuse
-Chair no arms

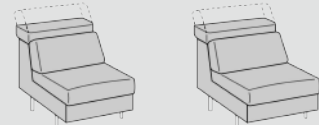

60

74

-Poltrona terminale
-Fauteuil terminal
-Terminal chair

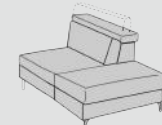

111x107

-Poltrona terminale
-Fauteuil terminal
-Terminal chair

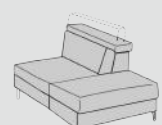

111x121

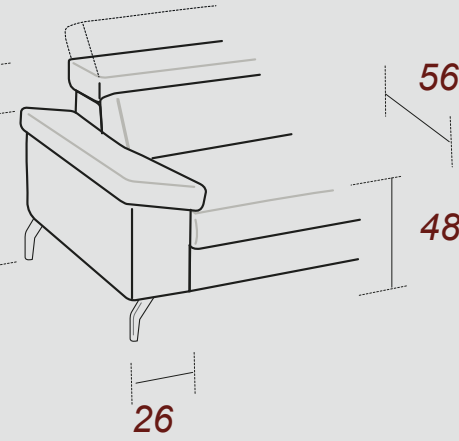

-2 Posti
-2 Places
-2 Seaters

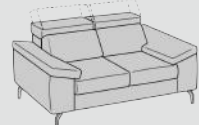

172

-2 Posti 1br
-Bat 2p
-2st 1arm

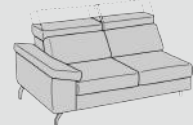

146

-3 Posti
-3 Places
-3 Seaters



200

-3 Posti 1br
-Bat 3p
-3st 1arm

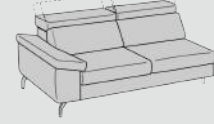

176

-Chaise Longue

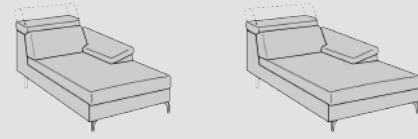

86 x 172

100 x 172

-Angolo
-Angle
-Corner

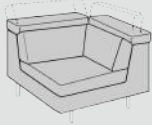

111 x 111

-Angolo terminale
-Angle terminal
-Terminal corner



111x220

-Angolo terminale
-Angle terminal
-Terminal corner



111x232

-Pouf rettangolare
-Pouf rectangulaire
-Rectangular footstool



70 x 100

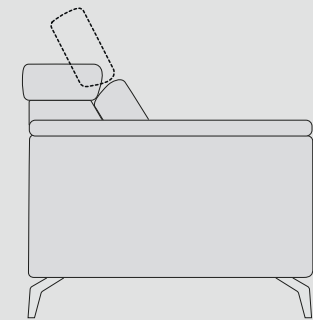

112

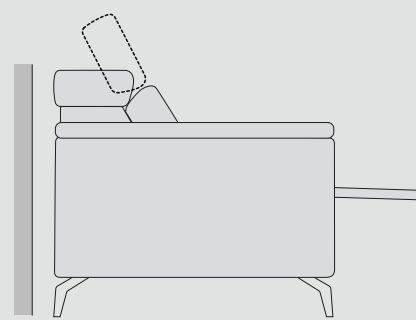

164

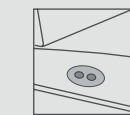

Pulsantiera Touch

Touch control panel

Panneau de commande tactile

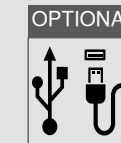

Connettore USB

NON DI SERIE

USB connector

NOT SERIES

Connecteur USB

HORS SÉRIE

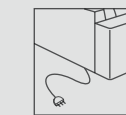

Attacco elettrico, di serie

Electric connection, standard.

Connexion électrique, standard.

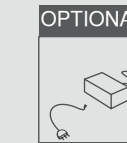

Alimentatore e batteria ricaricabile.

Power supply and battery rechargeable.

Alimentation et batterie rechargeable.

HORS SÉRIE

Fusto
Assemblaggio
Cinghie
Schienale
Braccioli
Seduta

Abete / multistrato / truciolare
Assemblaggio con colla e chiodi
Cinghie elastiche ad alta resistenza, intrecciate e incollate
Poliuretano espanso 21 kg/m³
Poliuretano espanso 21 kg/m³
Poliuretano espanso 35 kg/m³

Carcasse
Assemblage
Sangles
Dossiers
Accoudoirs
Assises

Sapin / Bois agglomeré EL / Fibres en bois/ Multicouche peuplier
Emboîtement avec colle, clous et pointes
Elastiques à haute résistance, tressées et clouées
Mousse polyuréthane 21 kg/m³
Mousse polyuréthane 21 kg/m³
Mousse polyuréthane 35 kg/m³

Frame
Assembly
Belts
Back Seat
Arms
Cushion Seat

Wood and derived
Assembly with screws and glue
Elastic and crossing belts
Mousse Polyurethane 21 kg/m³
Mousse Polyurethane 21 kg/m³
Mousse Polyurethane 35 kg/m³

Finitura Piedi in Metallo
Finition des Piedes Métal
Feet Metal Finishing

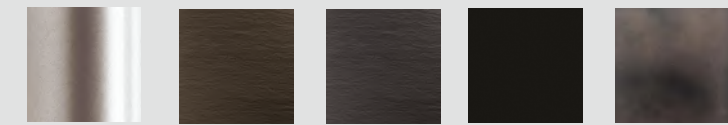

CHROME MOKA GRAFITE BLACK FUME'

