

# MARK

- Poltrona
- Fauteuil
- Chair

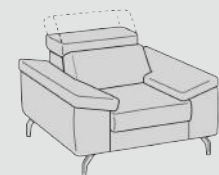

144

- Poltrona 1br
- Bat 1p
- Chair 1arm

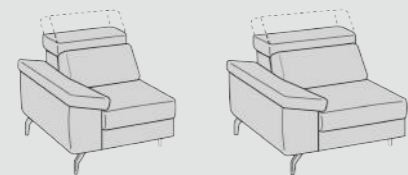

105

120

- Poltrona centrale
- Chaufeuse
- Chair no arms

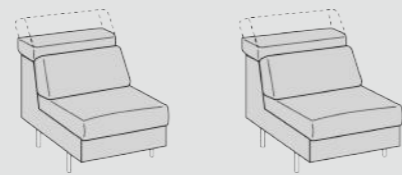

67

82

- Poltrona Terminale
- Fauteuil Terminal
- Terminal Chair

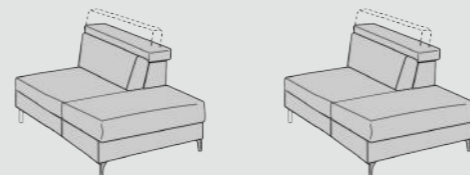

122

142

- 2 Posti
- 2 Places
- 2 Seaters

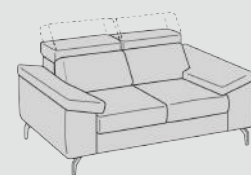

210

- 2 Posti 1br
- Bat 2p
- 2st 1arm

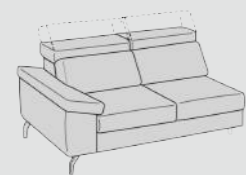

172

- Angolo quadro
- Angle carre
- Square corner

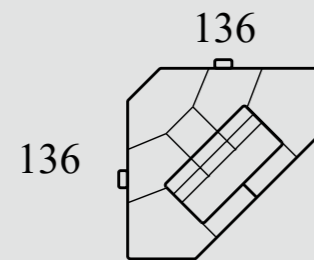

Chaise longue

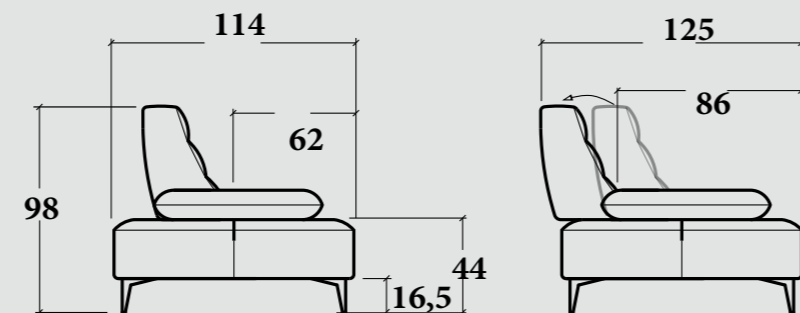

- 3 Posti
- 3 Places
- 3 Seaters

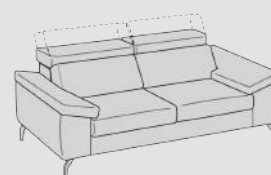

240

- 3 Posti 1br
- Bat 3p
- 3st 1arm

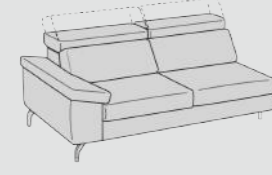

202

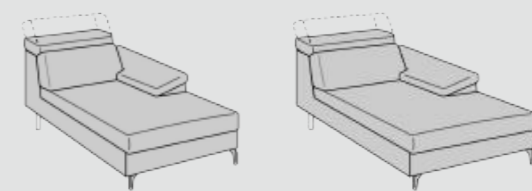

105x162

120 x 162

- Pouf quadrato
- Pouf carré
- Square footstool



65 x 80

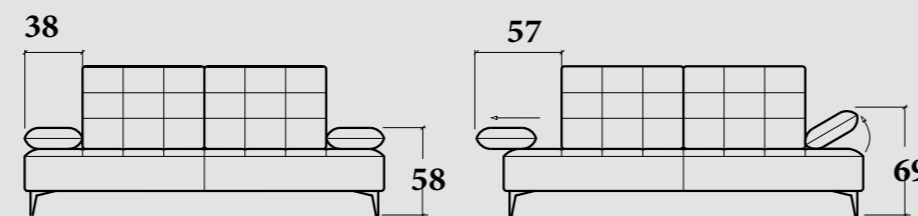

**Fusto** Abete / multistrato / truciolare  
**Assemblaggio** Assemblaggio con colla e chiodi  
**Cinghie** Cinghie elastiche ad alta resistenza, intrecciate e incollate  
**Schienale** Poliuretano espanso 21 kg/m<sup>3</sup>  
**Braccioni** Poliuretano espanso 21 kg/m<sup>3</sup>  
**Seduta** Poliuretano espanso 35 kg/m<sup>3</sup>

**Carcasse** Sapin / Bois aggloméré EL / Fibres en bois / Multicouche peuplier  
**Assemblage** Emboîtement avec colle, clous et pointes  
**Sangles** Élastiques à haute résistance, tressées et clouées  
**Dossiers** Mousse polyuréthane 21 kg/m<sup>3</sup>  
**Accoudoirs** Mousse polyuréthane 21 kg/m<sup>3</sup>  
**Assises** Mousse polyuréthane 35 kg/m<sup>3</sup>

**Frame** Wood and derived  
**Assembly** Assembly with screws and glue  
**Belts** Elastic and crossing belts  
**Back Seat** Mousse Polyurethane 21 kg/m<sup>3</sup>  
**Arms** Mousse Polyurethane 21 kg/m<sup>3</sup>  
**Cushion Seat** Mousse Polyurethane 35 kg/m<sup>3</sup>

**Finitura Piedi in Metallo**  
**Finition des Piedes Métal**  
**Feet Metal Finishing**

