

PETRUS

-Poltrona
-Fauteuil
-Chair

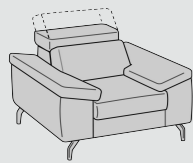

110

-Poltrona 1br
-Bat 1p
-Chair 1arm

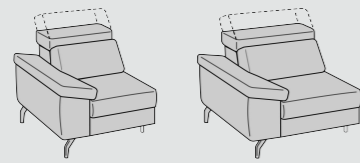

88

108

-Poltrona centrale
-Chaufeuse
-Chair no arms

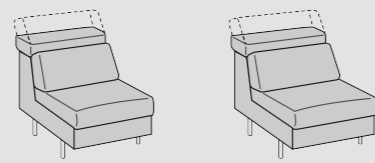

65

85

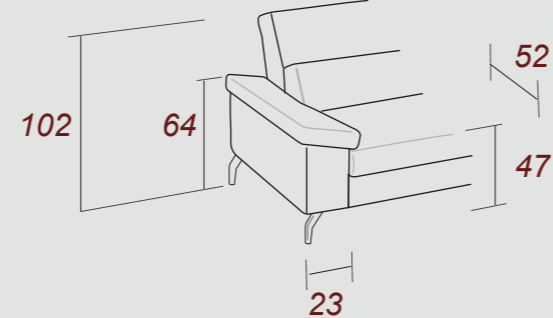

-2 Posti
-2 Places
-2 Seaters

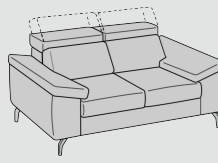

176

-2 Posti 1br
-Bat 2p
-2st 1arm

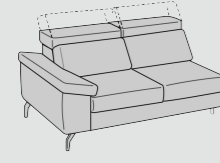

153

-Poltrona terminale
-Fauteuil terminal
-Terminal chair

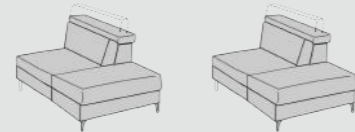

105x116

105 x 136

-3 Posti
-3 Places
-3 Seaters

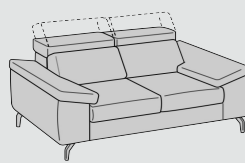

216

-3 Posti 1br
-Bat 3p
-3st 1arm

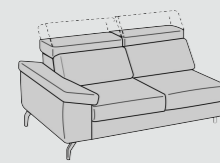

193

-Angolo terminale
-Angle terminal
-Terminal corner

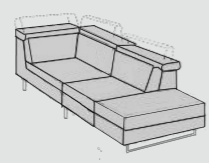

100 X 225

-Angolo
-Angle
-Corner

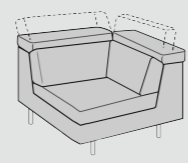

111 x 111

-Chaise Longue

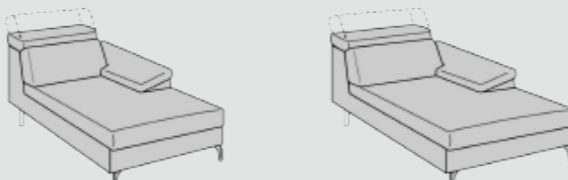

88 x 168



108 x 168



Struttura Sapin / Bois aggloméré EL / Fibras en bois/ Multicouche peuplier
Montaggio Emboîtement avec colle, clous et pointes
Tessitura Elastiques à haute résistance, tressées et clouées
Spalliera Ovatta
Braccioli Mousse polyuréthane 21 kg/m³
Seduta Mousse polyuréthane 35 kg/m³
Testiera Mousse polyuréthane 21 kg/m³

Carcasse Sapin / Bois aggloméré EL / Fibras en bois/ Multicouche peuplier
Assemblage Emboîtement avec colle, clous et pointes
Sangles Elastiques à haute résistance, tressées et clouées
Dossiers Ouate
Accoudoirs Mousse polyuréthane 21 kg/m³
Assises Mousse polyuréthane 35 kg/m³
Tetieres Mousse polyuréthane 21 kg/m³

Carcass Sapin / Bois aggloméré EL / Fibras en bois/ Multicouche peuplier
Assembly Emboîtement avec colle, clous et pointes
Webbing Elastiques à haute résistance, tressées et clouées
Back Seat Wadding
Arms Mousse polyuréthane 21 kg/m³
Cushion Seat Mousse polyuréthane 35 kg/m³
Headrests Mousse polyuréthane 21 kg/m³

Finitura Piedi in Metallo
Finition des Piedes Métal
Feet Metal Finishing

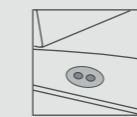

Pulsantiera Touch

Touch control panel

Panneau de commande tactile

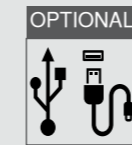

Connettore USB

USB connector

Connecteur USB

HORS SÉRIE

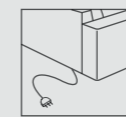

Attacco elettrico, di serie

Electric connection, standard.

Connexion électrique, standard.

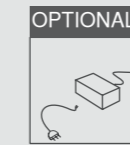

Alimentatore e batteria ricaricabile.

Power supply and battery rechargeable.

Alimentation et batterie rechargeable.

HORS SÉRIE

*Disegno a scopo dimostrativo

*Dessin à des fins de démonstration

*Drawing for demonstration purposes

