

SOANA

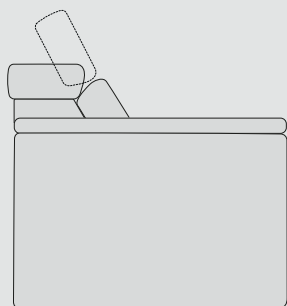

114

- Poltrona Letto materasso 70
- Fauteuil Lit couchage 70
- Chair Bed 70

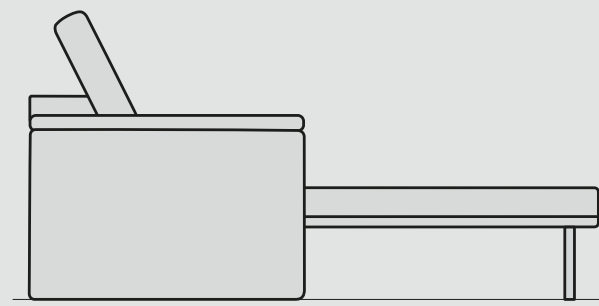

200

- 2 Posti letto 100
- 2 Places Lit couchage 100
- 2 Seater Sofa Bed 100

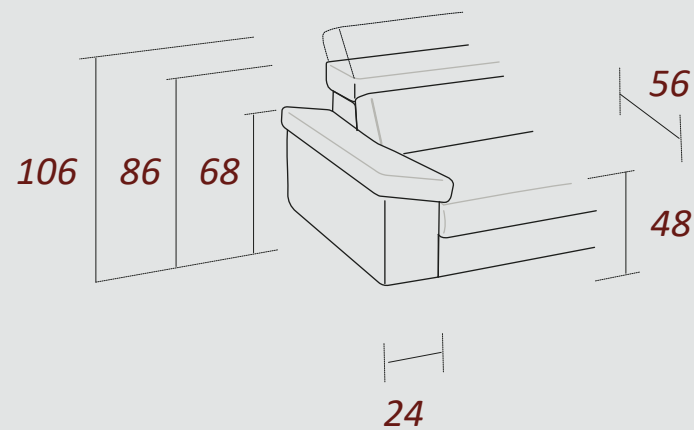

- 2 Posti letto 120
- 2 Places Lit couchage 120
- 2 Seater Sofa Bed 120

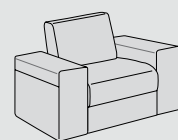

128

- 3Posti letto 140
- 3 Places Lit couchage 140
- 3 Seater Sofa Bed 140

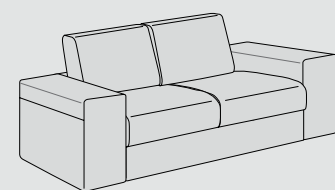

158

- 3 Posti maxi letto 160
- 3 Places Lit maxi couchage 160
- 3 Seater Sofa Bed maxi 160

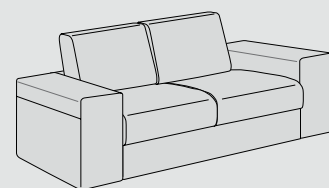

178

MATELAS 14cm

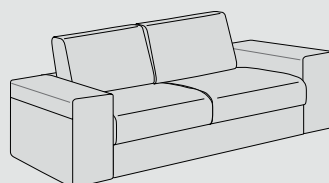

198

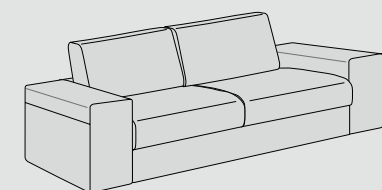

218

ALTONI
MADE IN ITALY

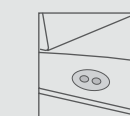

Pulsantiera Touch

Touch control panel

Panneau de commande tactile

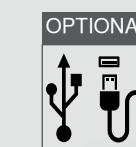

Connettore USB

USB connector

Connecteur USB

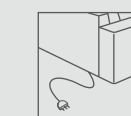

Attacco elettrico, di serie

Electric connection, standard.

Connexion électrique, standard.

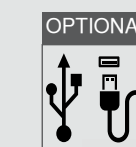

Connettore USB

USB connector

Connecteur USB

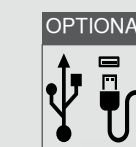

Attacco elettrico, di serie

Electric connection, standard.

Connexion électrique, standard.

Fusto
Assemblaggio
Rete meccanica

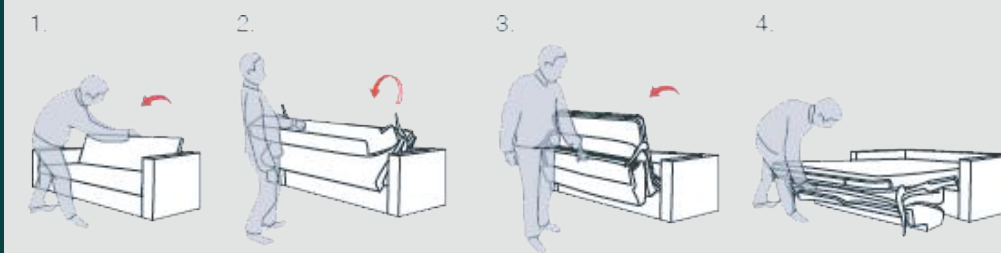

Abete / multistrato / truciolare
Assemblaggio con colla e chiodi
Elettrosaldato
Poliuretano espanso 21 kg/m³
Poliuretano espanso 18 kg/m³
Poliuretano espanso 30 kg/m³
14cm densità 30kg/m³

Schienale
Braccioli
Seduta

Materasso

Foam)

Carcasse Sapin / Bois aggloméré EL / Fibres en bois/ Multicouche peuplier
Assemblaggio Emboîtement avec colle, clous et pointes
Mecanica Elettrosaldato
Dossiers Mousse polyuréthane 21 kg/m³
Accoudoirs Mousse polyuréthane 18 kg/m³
Assises Mousse polyuréthane 30 kg/m³

Matelas

14 cm densità 30kg/m³

Frame Wood and derived
Assembly Assembly with screws and glue
Mechanical Electrowelded
Back Seat Mousse Polyurethane 21 kg/m³
Arms Mousse Polyurethane 18 kg/m³
Cushion Seat Mousse Polyurethane 30 kg/m³

Mattress

14 cm density 30kg/m³