

SPIDER

-Poltrona
-Fauteuil
-Chair



96

-Poltrona 1br
-Bat 1p
-Chair 1arm

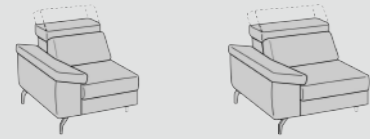

79

-Poltrona centrale
-Chaufeuse
-Chair no arms

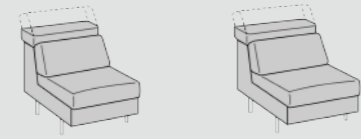

62



71

-Poltrona terminale
-Fauteuil terminal
-Terminal chair

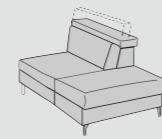

111

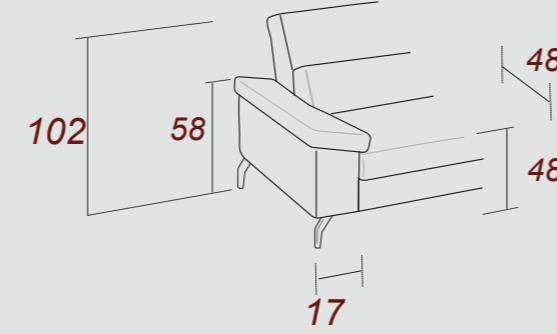

-2 Posti
-2 Places
-2 Seaters



158

-2 Posti 1br
-Bat 2p
-2st 1arm

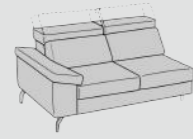

141

-2 Posti Maxi
-2 Places Maxi
-2 Seaters Maxi



176

-2 Posti Maxi 1br
-Bat 2p Maxi
-2st Maxi 1arm

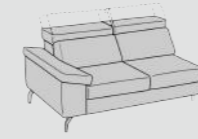

159

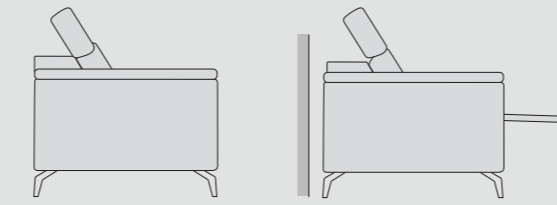

98

160

-3 Posti
-3 Places
-3 Seaters

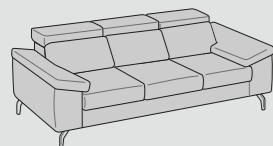

220

-3 Posti 1br
-Bat 3p
-3st 1arm

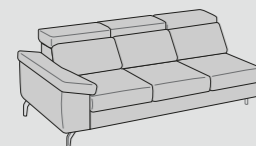

203

-Angolo terminale
-Angle terminal
-Terminal corner

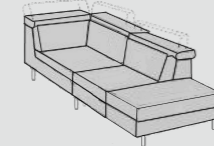

102 x 220

-Angolo quadro
-Angle carré
-Square corner

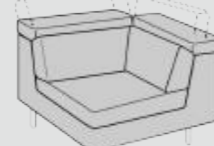

107x107

-Chaise Longue



79 x 165



Fusto Abete / multistrato / truciolare
Assemblaggio Assemblaggio con colla e chiodi
Cinghie Cinghie elastiche ad alta resistenza, intrecciate e incollate
Schienale Poliuretano espanso 21 kg/m³
Braccioli Poliuretano espanso 21 kg/m³
Seduta Poliuretano espanso 35 kg/m³

Carcasse Sapin / Bois aggloméré EL / Fibres en bois/ Multicouche peuplier
Assemblage Emboîtement avec colle, clous et pointes
Sangles Élastiques à haute résistance, tressées et clouées
Dossiers Mousse polyuréthane 21 kg/m³
Accoudoirs Mousse polyuréthane 21 kg/m³
Assises Mousse polyuréthane 35 kg/m³

Frame Wood and derived
Assembly Assembly with screws and glue
Belts Elastic and crossing belts
Back Seat Mousse Polyurethane 21 kg/m³
Arms Mousse Polyurethane 21 kg/m³
Cushion Seat Mousse Polyurethane 35 kg/m³

Finitura Piedi in Metallo
Finition des Piedes Métal
Feet Metal Finishing

S = Small
M = Medium
L = Large



MOKA GRAFITE CHROME BLACK FUME

TETIERES ATTIVES

