

# UBER

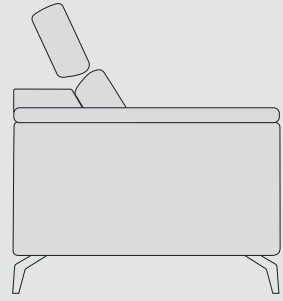

94

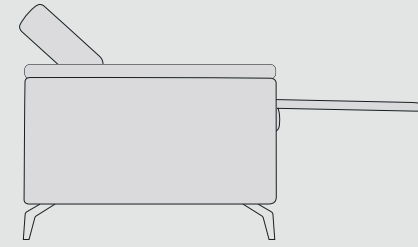

162

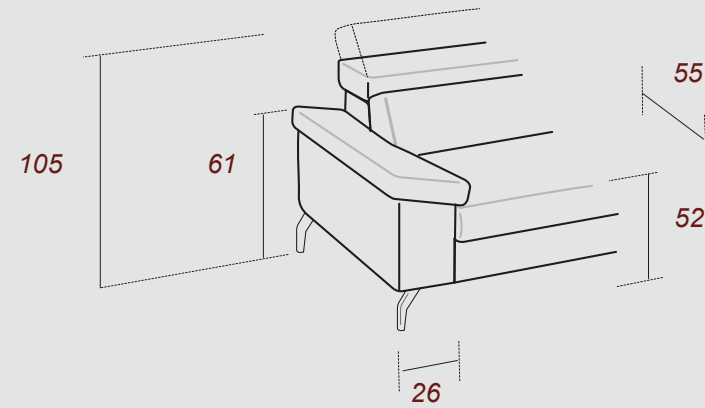

-Poltrona  
-Fauteuil  
-Chair

-2 Posti  
-2 Places  
-2 Seaters

-3 Posti  
-3 Places  
-3 Seaters

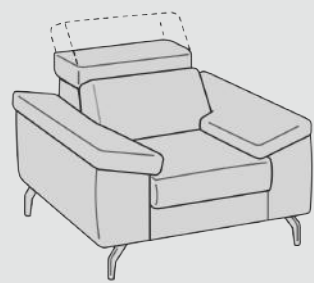

112

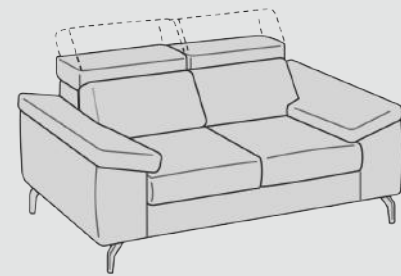

172

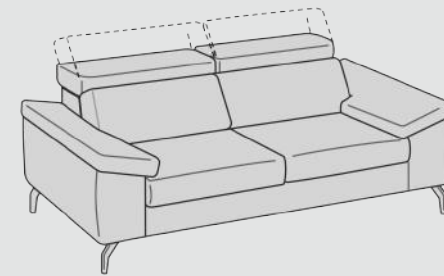

204

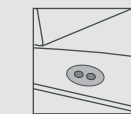

Pulsantiera Touch

Touch control panel

Panneau de  
commande tactile

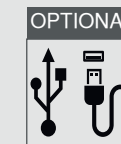

Connettore USB

USB connector

Connecteur USB

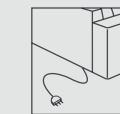

Attacco elettrico,  
di serie

Electric connection,  
standard.

Connexion électrique,  
standard.

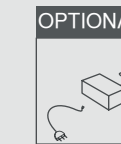

Alimentatore e batteria  
ricaricabile.

Power supply and battery  
rechargeable.

Alimentation et batterie  
rechargeable.

**Fusto** Abete / multistrato / truciolare  
**Assemblaggio** Assemblaggio con colla e chiodi  
**Cinghie** Cinghie elastiche ad alta resistenza, intrecciate e incollate  
**Schienale** Poliuretano espanso 21 kg/m<sup>3</sup>  
**Braccioli** Poliuretano espanso 21 kg/m<sup>3</sup>  
**Seduta** Poliuretano espanso 35 kg/m<sup>3</sup> e molle greche

**Carcasse** Sapin / Bois agglomeré EL / Fibres en bois/ Multicouche peuplier  
**Assemblage** Emboîtement avec colle, clous et pointes  
**Sangles** Élastiques à haute résistance, tressées et clouées  
**Dossiers** Mousse polyuréthane 21 kg/m<sup>3</sup>  
**Accoudoirs** Mousse polyuréthane 21 kg/m<sup>3</sup>  
**Assises** Mousse polyuréthane 35 kg/m<sup>3</sup> et ressorts

**Frame** Wood and derived  
**Assembly** Assembly with screws and glue  
**Belts** Elastic and crossing belts  
**Back Seat** Mousse Polyurethane 21 kg/m<sup>3</sup>  
**Arms** Mousse Polyurethane 21 kg/m<sup>3</sup>  
**Cushion Seat** Mousse Polyurethane 35 kg/m<sup>3</sup> and spring

