

VEGA

-Poltrona
-Fauteuil
-Chair

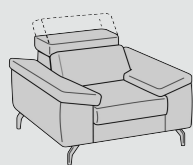

110

-Poltrona 1br
-Bat 1p
-Chair 1arm

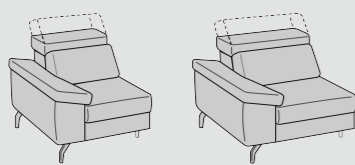

88

108

-Poltrona centrale
-Chaufeuse
-Chair no arms

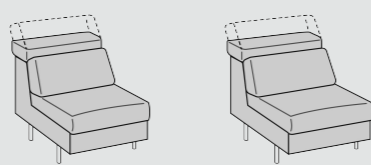

65

85

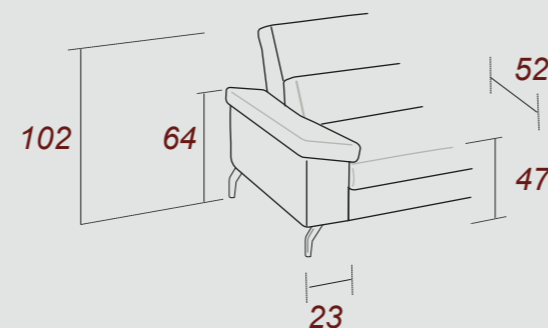

-2 Posti
-2 Places
-2 Seaters

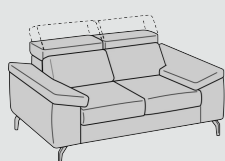

176

-2 Posti 1br
-Bat 2p
-2st 1arm

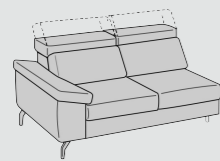

153

-3 Posti
-3 Places
-3 Seaters

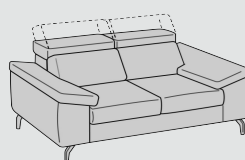

216

-3 Posti 1br
-Bat 3p
-3st 1arm

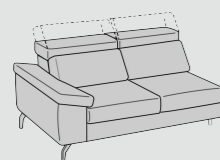

193

-Angolo terminale
-Angle terminal
-Terminal corner

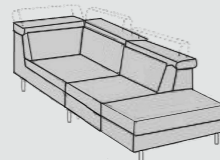

100 X 225

-Angolo
-Angle
-Corner

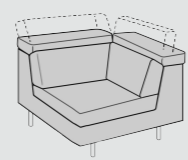

111 x 111

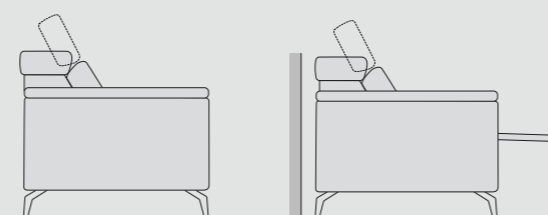

105

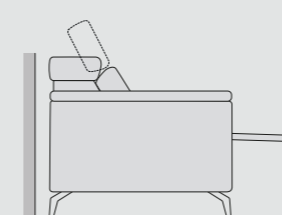

158



SISTEMI E COMPLEMENTI DISPONIBILI
AVAILABLE SYSTEMS AND COMPLEMENTS
SYSTÈMES ET COMPLÈMENTS DISPONIBLES

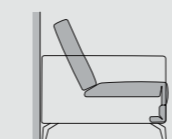

Posizione chiusa
Closed position
Position fermée

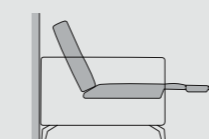

Posizione TV
TV position
Position TV

Metodo di controllo
Control method
Methode de controle

Kit di attivazione
Activation kit
Kit d'activation

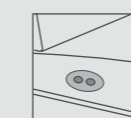

Pulsantiera Touch

Touch control panel

Panneau de
commande tactile

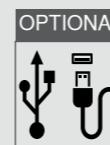

Connettore USB

NON DI SERIE

USB connector

NOT SERIES

Connecteur USB

HORS SÉRIE

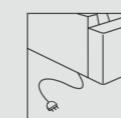

Attacco elettrico,
di serie

Electric connection,
standard.

Connexion électrique,
standard.

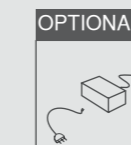

Alimentatore e batteria
ricaricabile.

Power supply and battery
rechargeable.

Alimentation et batterie
rechargeable.

HORS SÉRIE



Struttura Sapin / Bois aggloméré EL / Fibres en bois/ Multicouche peuplier
Montaggio Emboîtement avec colle, clous et pointes
Tessitura Elastiques à haute résistance, tressées et clouées
Spalliera Ovatta
Braccioli Mousse polyuréthane 21 kg/m³
Seduta Mousse polyuréthane 35 kg/m³
Testiera Mousse polyuréthane 21 kg/m³



Carcasse Sapin / Bois aggloméré EL / Fibres en bois/ Multicouche peuplier
Assemblage Emboîtement avec colle, clous et pointes
Sangles Elastiques à haute résistance, tressées et clouées
Dossiers Ouate
Accoudoirs Mousse polyuréthane 21 kg/m³
Assises Mousse polyuréthane 35 kg/m³
Tetiere Mousse polyuréthane 21 kg/m³



Carcass Sapin / Bois aggloméré EL / Fibres en bois/ Multicouche peuplier
Assembly Emboîtement avec colle, clous et pointes
Webbing Elastiques à haute résistance, tressées et clouées
Back Seat Wadding
Arms Mousse polyuréthane 21 kg/m³
Cushion Seat Mousse polyuréthane 35 kg/m³
Headrests Mousse polyuréthane 21 kg/m³

Finitura Piedi in Metallo
Finition des Piedes Métal
Feet Metal Finishing

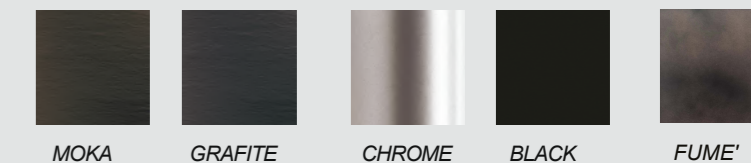

* **Disegno a scopo dimostrativo**

* **Dessin à des fins de démonstration**

* **Drawing for demonstration purposes**

